











 Szyna TH35
/ TH (DIN) Rail



ROZDZIELNICE HERMETYCZNE RH/UV

- PRZYGOTOWANIE DO MONTAŻU

/ RH/UV HERMETIC DISTRIBUTION BOARDS

- PREPARATION FOR ASSEMBLY

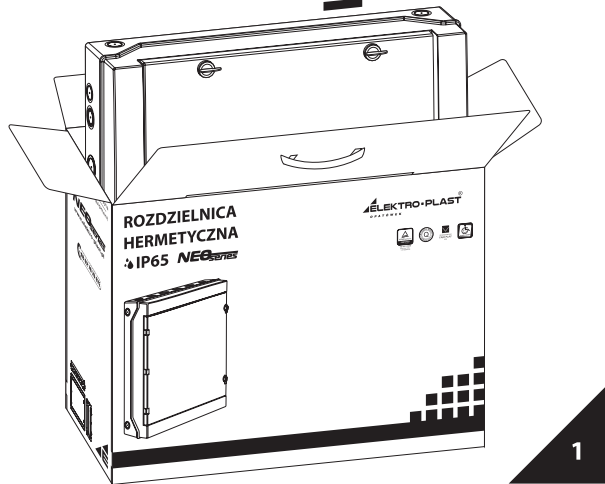
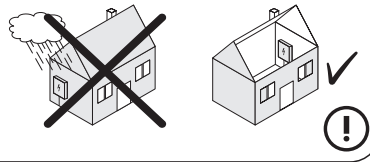
Rozdzielnica / Distribution Board	Szyna TH35 / TH (DIN) Rail				Listwa zaciskowa LZ / Connector strip LZ			Wkręty / Screws	Zaślepka wkrętów / Screw plug	Pole opisowe - samoprzylepne / Description field - sticker
	Symbol	Nr kat. / Cat No.	Symbol	Szt. / Pcs.	Nr kat. / Cat No.	Symbol	Szt. / Pcs.			
 RH-4/UV	33.112	WTH3	1	47.114	LZ-4	1	4	4	1	
 RH-6/UV	33.164	WTH9	1	47.116	LZ-6	1	4	4	1	
 RH-8/UV	33.199	WTH13	1	47.108	LZ-8	1	4	4	1	
 RH-12/UV	33.266	WTH17	1	47.112	LZ-12	1	4	4	1	
 RH-18/UV	33.372	WTH20	1	47.118	LZ-18	1	4	4	1	
 RH-24/UV	33.266	WTH17	2	47.112	LZ-12	2	8	4	2	
 RH-36/2/UV	33.372	WTH20	2	47.118	LZ-18	2	8	4	2	
 RH-36/3/UV	33.266	WTH17	3	47.112	LZ-12	2	14	4	3	
				47.116	LZ-6	2				
 RH-54/UV	33.372	WTH20	3	47.108	LZ-8	2	12	4	3	
				47.118	LZ-18	2				
 RH-72/UV	33.372	WTH20	4	47.118	LZ-18	4	16	4	4	



1

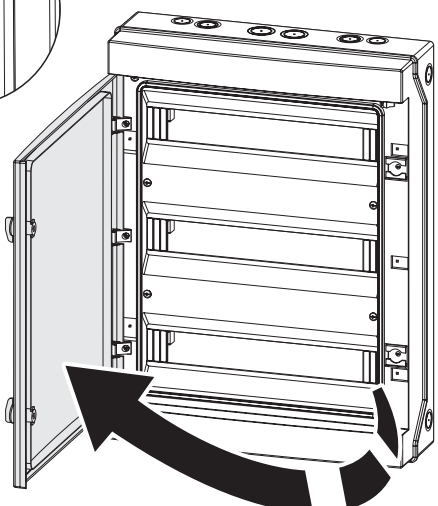
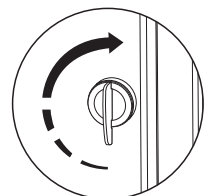

2

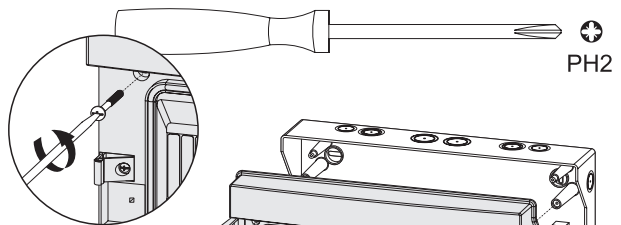

PH2

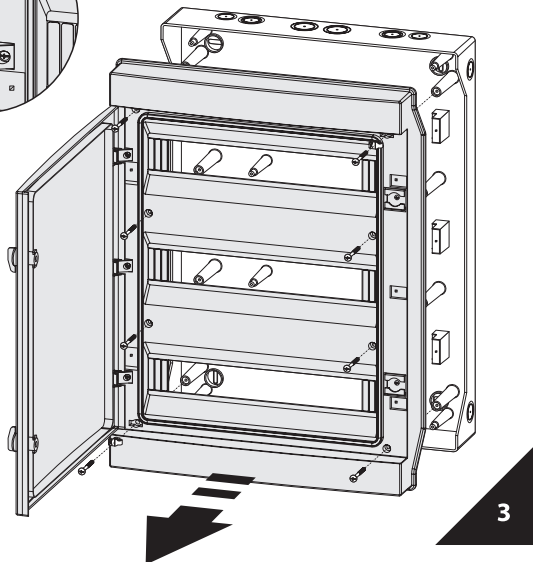

3

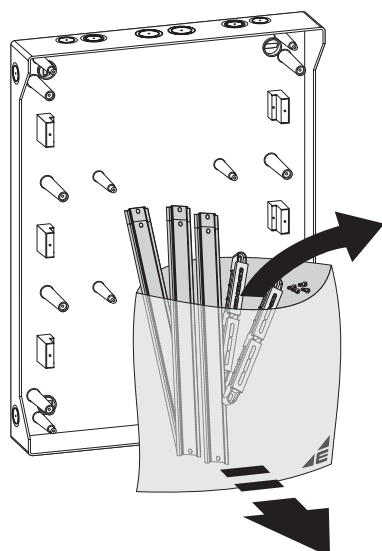
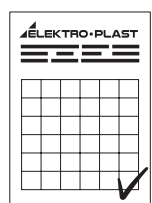

4

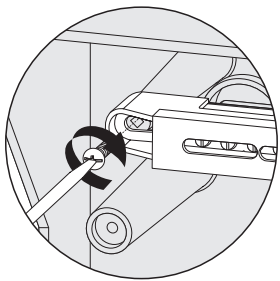

! max. 1.8Nm

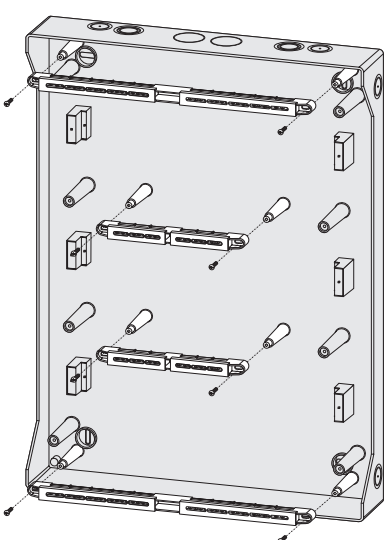

5



! max. 1.8Nm

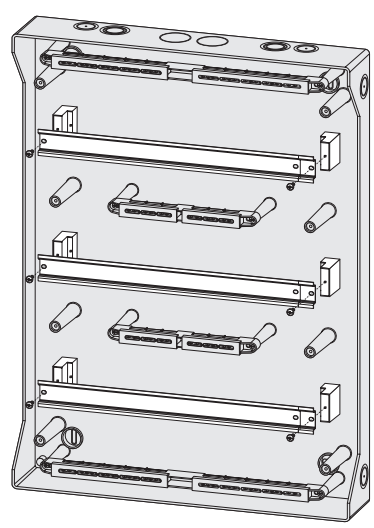

6